

Single-Axis Robot

3. SK Series

The HIWIN SK quiet single-axis robot with SynchMotion™ Technology offers quieter operation, smooth movement, low particle emission rate, longer service life and superior lubrication. With the SynchMotion™ Technology, SK single-axis robots will be more suitable for industries which require higher speeds and quieter performance.

3.1 Features

- ⊙ Low noise
- ⊙ Low particle emission rate
- ⊙ Longer service life
- ⊙ Superior lubrication
- ⊙ Easy installation and maintenance

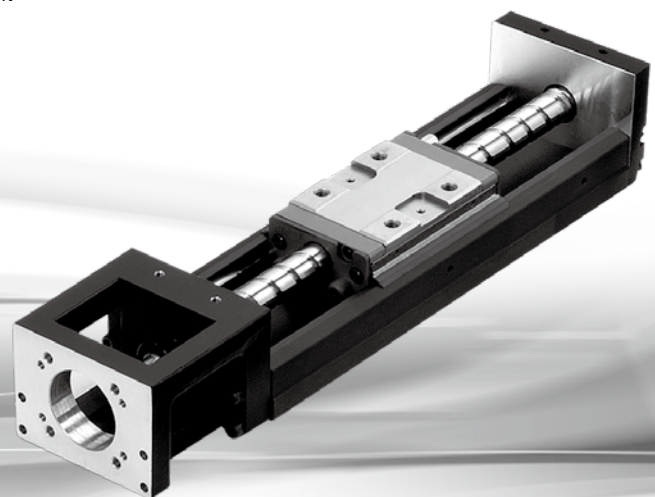
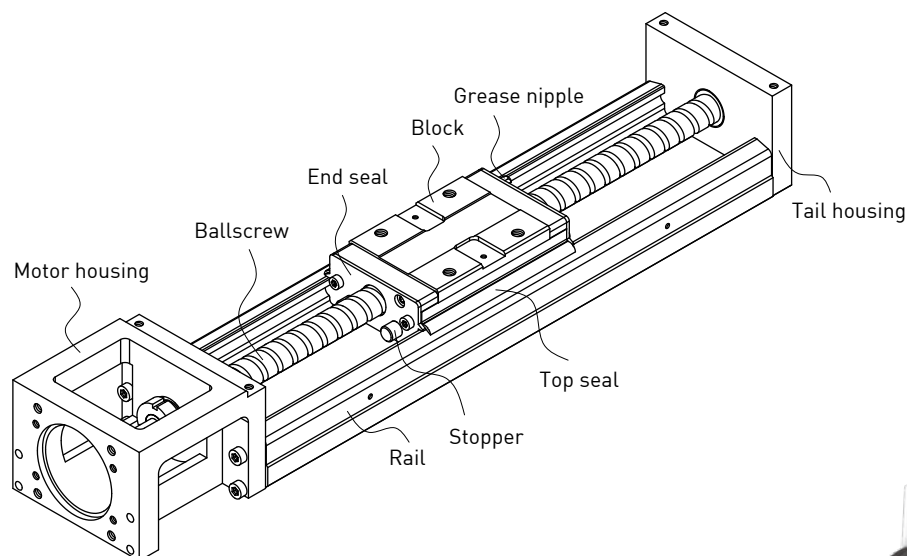

3.1.1 SynchMotion™ Technology

With SynchMotion™ Technology, the rolling elements are interposed between the partitions of SynchMotion™ to provide improved circulation. By eliminating the contact between the rolling elements, collision noise and sound levels are greatly reduced.

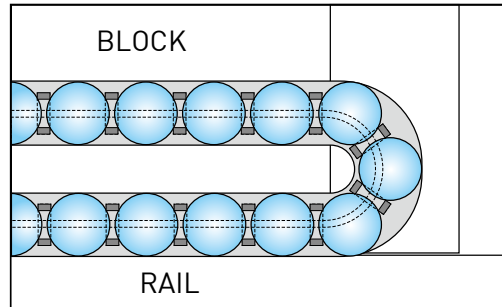

3.1.2 Tangent Circulation Technology

The rolling elements enter the circulation system by following the spiral pathway. When compared to the traditional external circulation, the Tangent Circulation Technology diminishes the impact caused by the rolling elements entering the circulation system, improving the speed, acceleration and smoothness while reducing the noise.

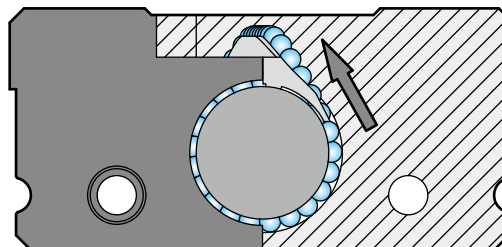

3.1.3 Noise Test

Incorporating both SynchMotion™ Technology and Tangent Circulation Technology, the noise reduction is about 3-5 dB during operation.

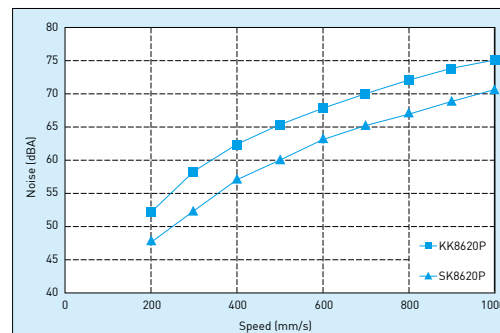

3.2 Model Number of SK Series

SK	60D	10	P	E	-	400	E	A	2	E	-	FO	C	S0	M051
-----------	------------	-----------	----------	----------	----------	------------	----------	----------	----------	----------	----------	-----------	----------	-----------	-------------

SK Series

Nominal Width:
60, 60D, 86, 86D

Ballscrew Lead :
SK60/SK60D: 5, 10
SK86/SK86D: 10, 20

Accuracy Grade:
P: Precision, C: Normal

E: Ballscrew Special Order
None: Normal Type

Rail Length (unit : mm)
SK60/SK60D : 150, 200, 300, 400, 500, 600
SK86/SK86D : 340, 440, 540, 640, 740, 940

E: Rail Special Order
None: Normal Type

Block Type:
A: Standard, S: Light Duty

Number of Blocks: 1 or 2

Motor specification:
ref. catalog P.65
M: customer specified

Limit Switch:
ref. catalog (P.67)
S0: Switch Rail Only
S1: Omron SX671
S2: Omron SX674
S3: SUNX GX-F12A
S4: SUNX GX-F12A-P
SE: Sensor Special Order
None: No Limit Switch and Switch Rail

C: Aluminum Cover
None: Normal Type

Motor Adaptor Flange
ref. catalog (P.66)
FE : Flange Special Order

E: Block Special Order
None: Block Standard

3.3 Specifications

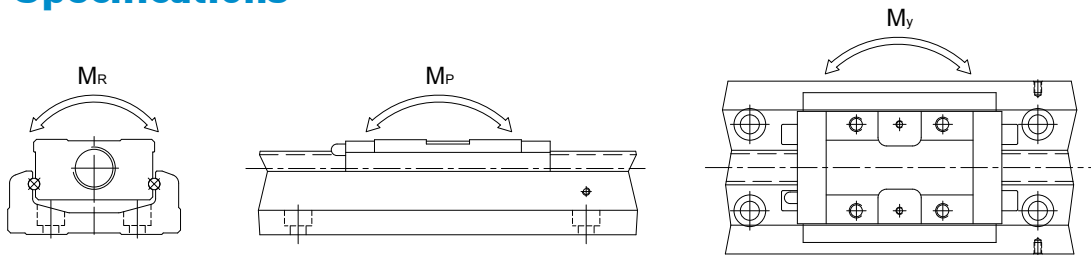

Model No.	Ballscrew				Guideway																
	Nominal Diameter (mm)	Lead (mm)	Basic Dynamic Load (N)	Basic Static Load (N)	Basic Dynamic Load Rating (N)	Basic Dynamic Load Rating (N)	Basic Static Load Rating (N)	Basic Static Load Rating (N)	Static Rated Moment												
									Allowable Static Moment M_p (N-m) [pitching]				Allowable Static Moment M_y (N-m) [yawing]				Allowable Static Moment M_R (N-m) [rolling]				
									Block A1	Block A2	Block S1	Block S2	Block A1	Block A2	Block S1	Block S2	Block A1	Block A2	Block S1	Block S2	
SK6005	Precision	12	5	3744	6243	15132	9900	19811	10800	168	891	60	366	168	891	60	366	413	826	245	490
SK6005	Normal			3377	5626																
SK6010	Precision	12	10	2410	3743	15132	9900	19811	10800	168	891	60	366	168	891	60	366	413	826	245	490
SK6010	Normal			2107	3234																
SK8610	Precision	15	10	7144	12642	26011	17580	35793	20450	565	2481	210	1281	565	2481	210	1281	1063	2126	635	1270
SK8610	Normal			6429	11387																
SK8620	Precision	15	20	4645	7655	26011	17580	35793	20450	565	2481	210	1281	565	2481	210	1281	1063	2126	635	1270
SK8620	Normal			4175	6889																

3.4 Accuracy Grade

Unit : mm

Model	Rail Length	Repeatability		Accuracy		Running Parallelism		Starting Torque(N-cm)	
		Precision	Normal	Precision	Normal	Precision	Normal	Precision	Normal
SK60	150	±0.003	±0.005	0.020	-	0.010	-	15	7
	200								
	300								
	400								
	500	±0.003	±0.005	0.025	-	0.015	-	15	7
	600								
SK86	340	±0.003	±0.005	0.025	-	0.015	-	15	10
	440								
	540								
	640								
	740	±0.003	±0.005	0.030	-	0.020	-	17	10
	940								

3.5 Maximum Speed Limit

Model	Ballscrew Lead (mm)	Rail Length (mm)	Speed (mm/sec)	
			Precision	Normal
SK60	05	150	550	390
		200	550	390
		300	550	390
		400	550	390
		500	550	390
		600	340	340
	10	150	1100	790
		200	1100	790
		300	1100	790
		400	1100	790
		500	1100	790
		600	670	670
SK86	10	340	740	520
		440	740	520
		540	740	520
		640	740	520
		740	740	520
		940	610	430
	20	340	1480	1050
		440	1480	1050
		540	1480	1050
		640	1480	1050
		740	1480	1050
		940	1220	870

3.6 Life Calculations

3.6.1 Service Life

Under repeated stress between the raceway and the rolling elements, pitting and flaking will occur as it reaches fatigue failure. The service life of the SK single-axis robot is defined as the distanced traveled before any failure of the raceway or rolling elements appear.

3.6.2 Nominal Life (L)

The service life varies greatly even when the SK units are manufactured in the same way or operated under the same conditions. For this reason, nominal life is used as the criteria for predicting the service life of a SK unit.

3.6.3 Nominal Life Calculation

The calculating formulas are divided into two parts, guideway and ballscrew. The smaller of the two values would be the recommended nominal life of the SK unit.

Nominal life formulas for both the guideway and ballscrew depend on several parameters as shown below:

◎ Guideway

$$L = \left(\frac{f_t}{f_w} \cdot \frac{C}{P_n} \right)^3 \times 50 \text{ km}$$

L : Life Rating (km) C : Basic Dynamic Load Rating (N)
 f_t : Contact Coefficient (ref. Table 1) P_n : Calculated Loading (N)
 f_w : Loading Coefficient (ref. Table 2)

Table 1

Block type	Contact Coefficient f_t
A1, S1	1.0
A2, S2	0.81

Table 2

Operating Condition		Loading Coefficient f_w
Thrust and Vibration	Velocity (V)	
No Thrust	V < 15m/min	1.0 ~ 1.5
Low Vibration	15m/min < V < 60m/min	1.5 ~ 2.0
High Vibration	V > 60m/min	2.0 ~ 3.5

◎ Ballscrew and Bearing

$$L = \left(\frac{1}{f_w} \cdot \frac{C_a}{P_{a,n}} \right)^3 \times 10^6 \text{ rev}$$

L : Life Rating (rev.) C_a : Basic Dynamic Load Rating (N)
 f_w : Loading Coefficient (ref. Table 2) $P_{a,n}$: Axial Loading (N)

3.7 Lubrication

Insufficient lubrication of the guideway would lead to a reduction of the service life.

The lubricant provides the following functions:

- ⊙ Reducing rolling friction and avoiding abrasion
- ⊙ Providing a lubricating film and extending the service life
- ⊙ Anti-rusting

3.7.1 Lubricating grease

Re-lubricating the SK single-axis robot every 100km is recommended. Generally, grease is applied for speeds under 60 m/min. For operating speeds over 60 m/min, a grease with a higher viscosity should be used.

$$T = \frac{100 \times 1000}{V_e \times 60}$$

T : Lubricating frequency (hrs)
V_e : Speed (m/min)

3.7.2 Grease nipple

⊙ 1 block

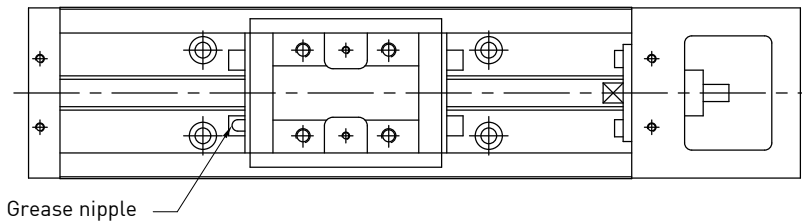

⊙ 2 blocks

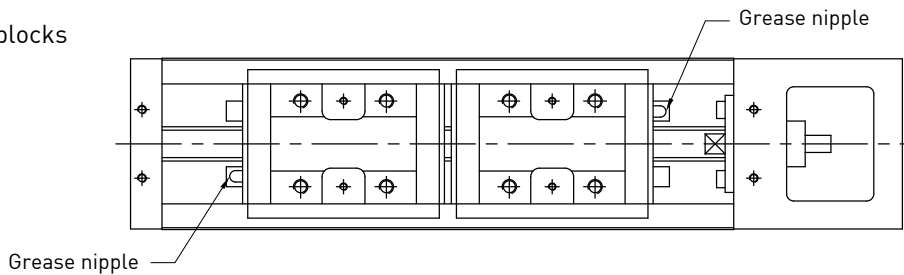

Type of grease nipple

SK60
SK86

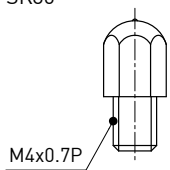

NO. 34310002

3.8 Dimensions

3.8.1 Without cover

SK60 (Standard)

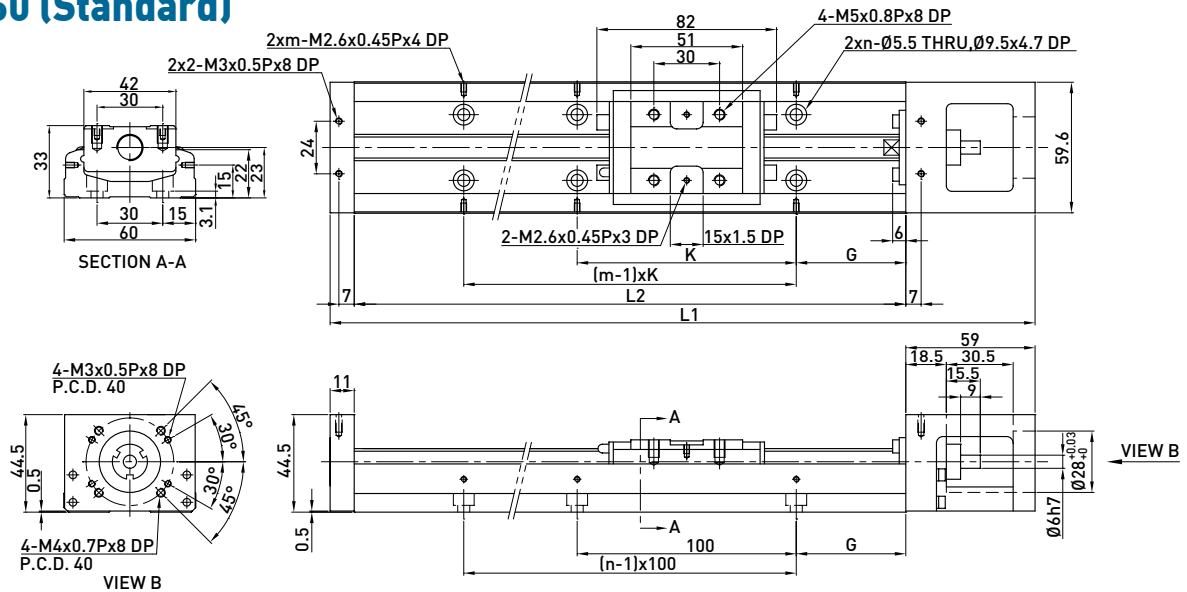

Rail Length L2 (mm)	Total Length L1 (mm)	Maximum Stroke (mm)		G (mm)	K (mm)	n	m	Mass (kg)	
		A1 Block	A2 Block					A1 Block	A2 Block
150	220	60	-	25	100	2	2	1.5	-
200	270	110	-	50	100	2	2	1.8	-
300	370	210	135	50	200	3	2	2.4	2.7
400	470	310	235	50	100	4	4	3	3.3
500	570	410	335	50	200	5	3	3.6	3.9
600	670	510	435	50	100	6	6	4.2	4.6

Note: Special ballscrew spindle end of 8 mm diameter is available, please contact hiwin if necessary.

SK60 (Light Duty)

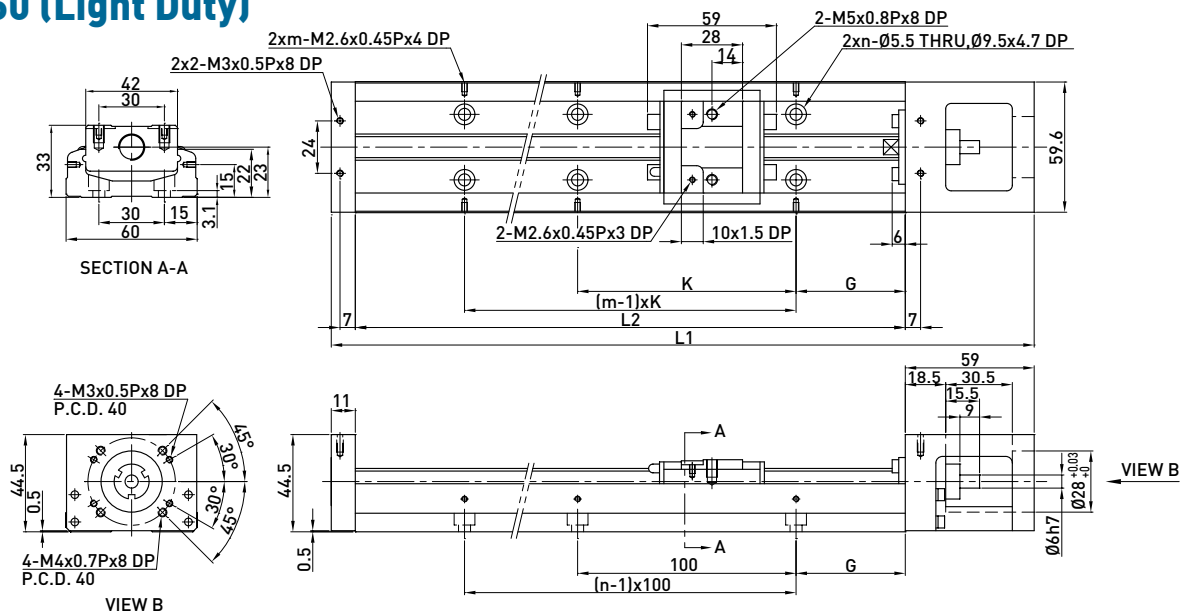

Rail Length L2 (mm)	Total Length L1 (mm)	Maximum Stroke (mm)		G (mm)	K (mm)	n	m	Mass (kg)	
		S1 Block	S2 Block					S1 Block	S2 Block
150	220	85	34	25	100	2	2	1.4	1.6
200	270	135	84	50	100	2	2	1.7	1.9
300	370	235	184	50	200	3	2	2.3	2.5
400	470	335	284	50	100	4	4	2.9	3.1
500	570	435	384	50	200	5	3	3.5	3.7
600	670	535	484	50	100	6	6	4.1	4.3

SK60D (Standard)

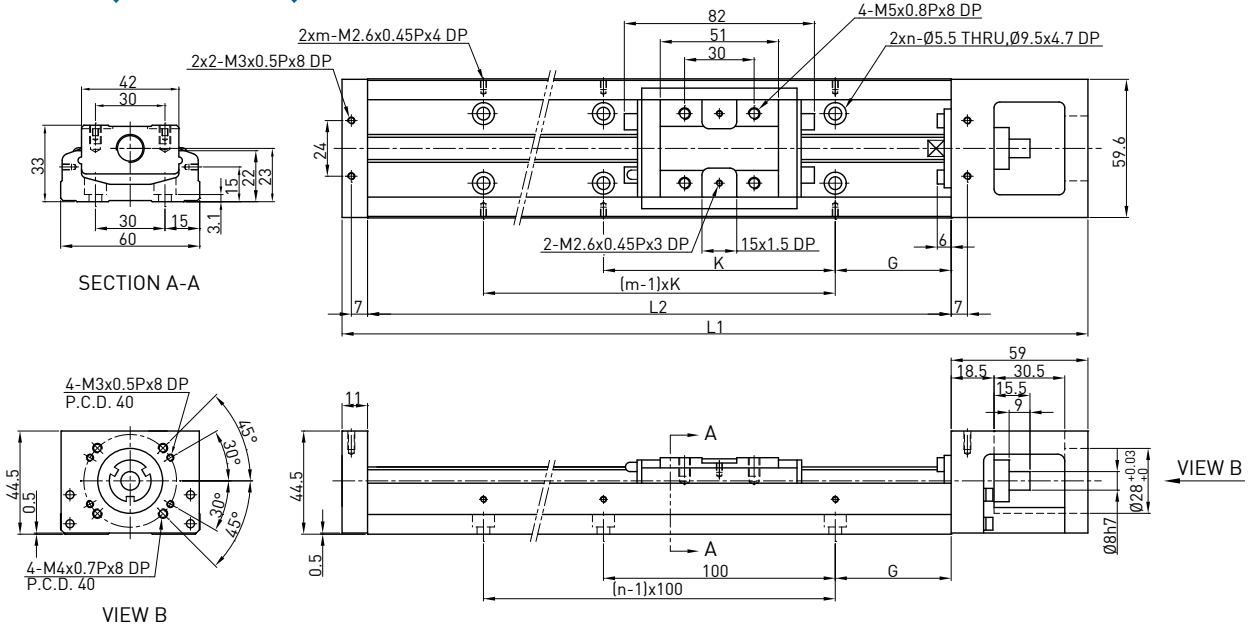

Rail Length L2 (mm)	Total Length L1 (mm)	Maximum Stroke (mm)		G (mm)	K (mm)	n	m	Mass (kg)	
		A1 Block	A2 Block					A1 Block	A2 Block
150	220	60	-	25	100	2	2	1.5	-
200	270	110	-	50	100	2	2	1.8	-
300	370	210	135	50	200	3	2	2.4	2.7
400	470	310	235	50	100	4	4	3	3.3
500	570	410	335	50	200	5	3	3.6	3.9
600	670	510	435	50	100	6	6	4.2	4.6

SK60D (Light Duty)

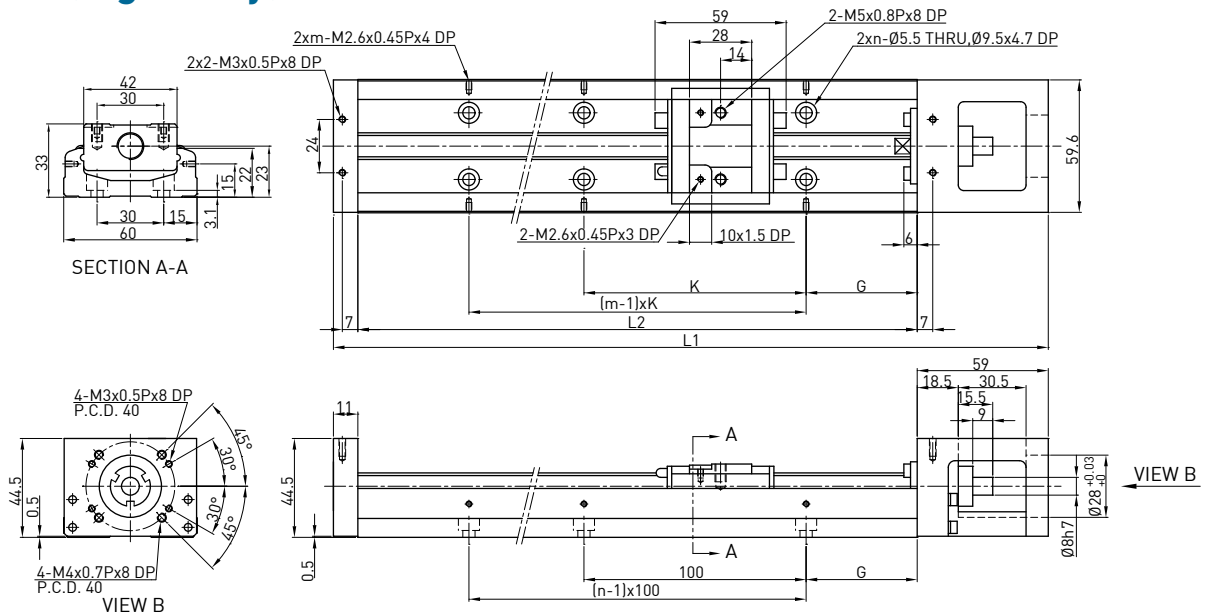

Rail Length L2 (mm)	Total Length L1 (mm)	Maximum Stroke (mm)		G (mm)	K (mm)	n	m	Mass (kg)	
		S1 Block	S2 Block					S1 Block	S2 Block
150	220	85	34	25	100	2	2	1.4	1.6
200	270	135	84	50	100	2	2	1.7	1.9
300	370	235	184	50	200	3	2	2.3	2.5
400	470	335	284	50	100	4	4	2.9	3.1
500	570	435	384	50	200	5	3	3.5	3.7
600	670	535	484	50	100	6	6	4.1	4.3

SK86 (Standard)

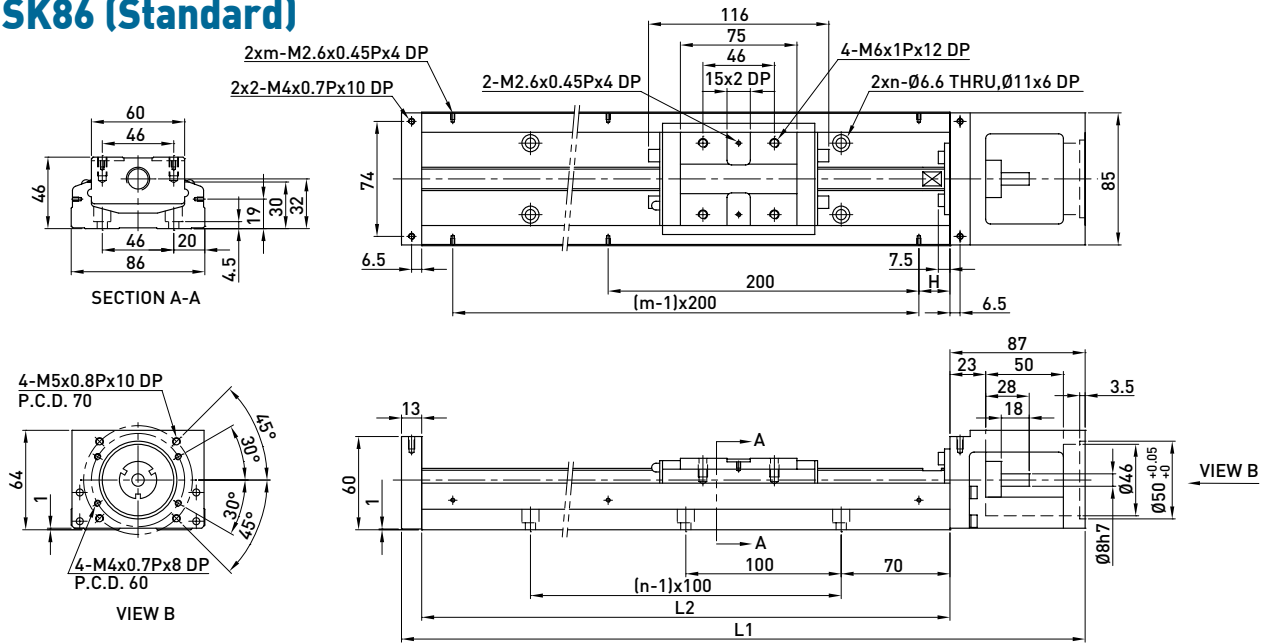

Rail Length L2 (mm)	Total Length L1 (mm)	Maximum Stroke (mm)		H (mm)	n	m	Mass (kg)	
		A1 Block	A2 Block				A1 Block	A2 Block
340	440	216.5	108.5	70	3	2	5.7	6.5
440	540	316.5	208.5	20	4	3	6.9	7.7
540	640	416.5	308.5	70	5	3	8.0	8.8
640	740	516.5	408.5	20	6	4	9.2	10.0
740	840	616.5	508.5	70	7	4	10.4	11.2
940	1040	816.5	708.5	70	9	5	11.6	12.4

Note: Special ballscrew spindle end of 10 mm diameter is available, please contact hiwin if necessary.

SK86 (Light Duty)

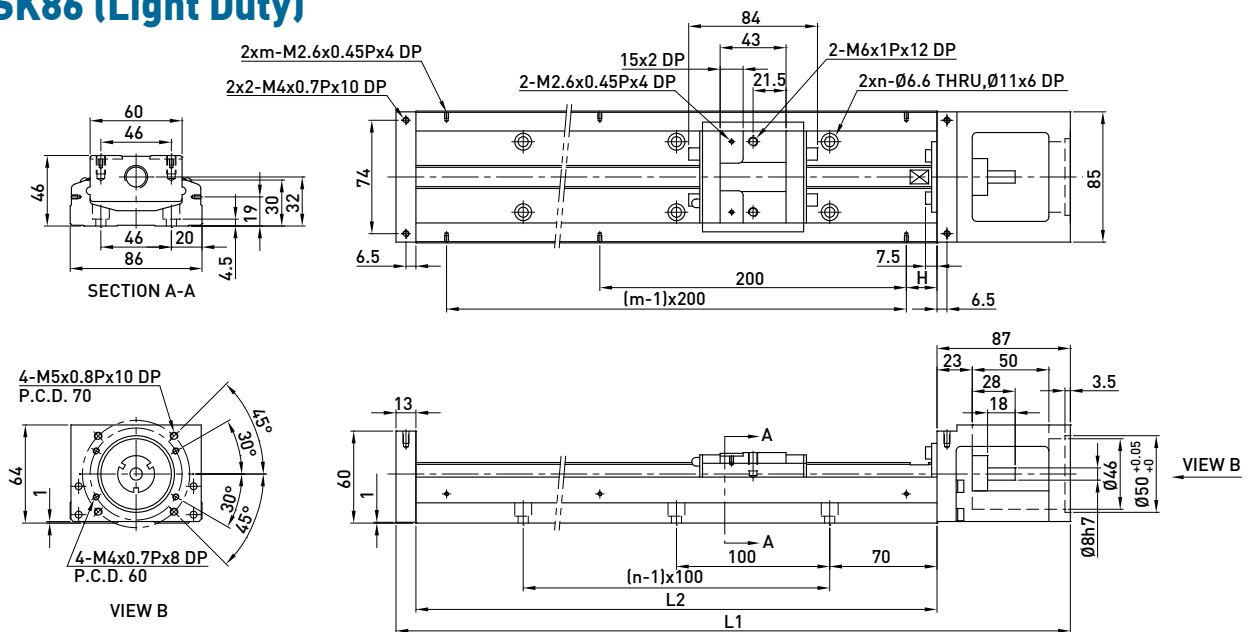

Rail Length L2 (mm)	Total Length L1 (mm)	Maximum Stroke (mm)		H (mm)	n	m	Mass (kg)	
		S1 Block	S2 Block				S1 Block	S2 Block
340	440	248.5	172.5	70	3	2	5.4	5.9
440	540	348.5	272.5	20	4	3	6.6	7.1
540	640	448.5	372.5	70	5	3	7.7	8.2
640	740	548.5	472.5	20	6	4	8.9	9.4
740	840	648.5	572.5	70	7	4	10.1	10.6
940	1040	848.5	772.5	70	9	5	11.3	11.8

SK86D (Standard)

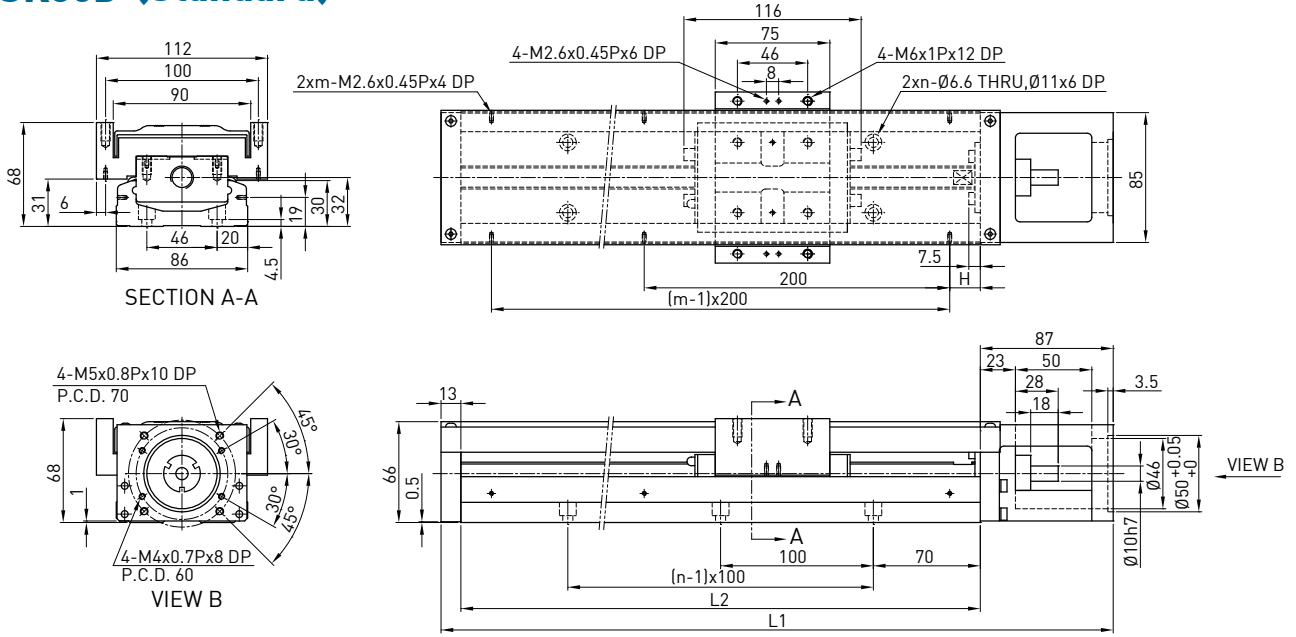

Rail Length L2 (mm)	Total Length L1 (mm)	Maximum Stroke (mm)		H (mm)	n	m	Mass (kg)	
		A1 Block	A2 Block				A1 Block	A2 Block
340	440	216.5	108.5	70	3	2	6.5	7.3
440	540	316.5	208.5	20	4	3	7.8	8.6
540	640	416.5	308.5	70	5	3	9.0	9.8
640	740	516.5	408.5	20	6	4	10.3	11.3
740	840	616.5	508.5	70	7	4	11.6	12.4
940	1040	816.5	708.5	70	9	5	13.0	13.8

SK86D (Light Duty)

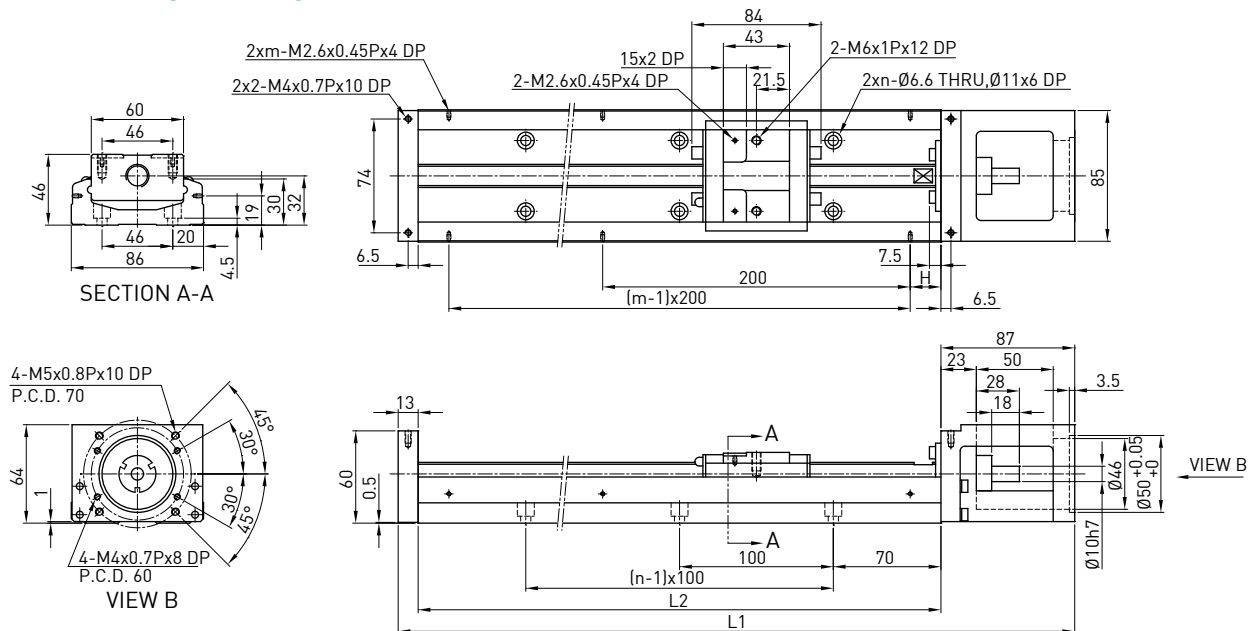

Rail Length L2 (mm)	Total Length L1 (mm)	Maximum Stroke (mm)		H (mm)	n	m	Mass (kg)	
		S1 Block	S2 Block				S1 Block	S2 Block
340	440	248.5	172.5	70	3	2	5.4	5.9
440	540	348.5	272.5	20	4	3	6.6	7.1
540	640	448.5	372.5	70	5	3	7.7	8.2
640	740	548.5	472.5	20	6	4	8.9	9.4
740	840	648.5	572.5	70	7	4	10.1	10.6
940	1040	848.5	772.5	70	9	5	11.3	11.8

2.8.2 With cover

SK60 (Standard)

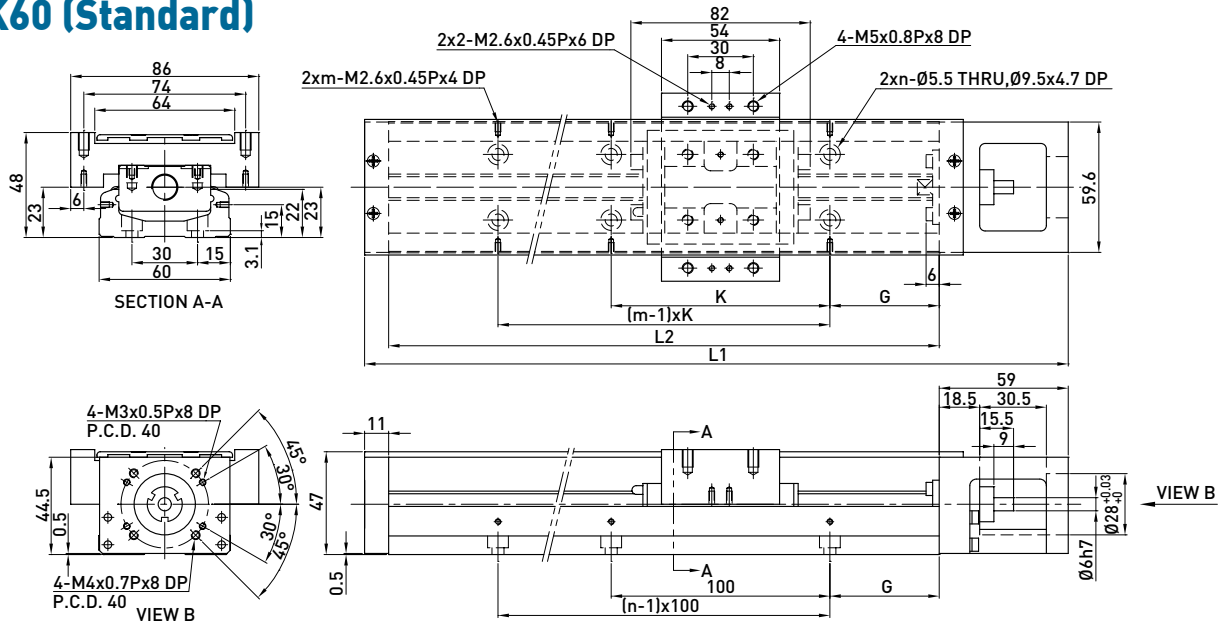

Rail Length L2 (mm)	Total Length L1 (mm)	Maximum Stroke (mm)		G (mm)	K (mm)	n	m	Mass (kg)	
		A1 Block	A2 Block					A1 Block	A2 Block
150	220	60	-	25	100	2	2	1.7	-
200	270	110	-	50	100	2	2	2.1	-
300	370	210	135	50	200	3	2	2.7	3.0
400	470	310	235	50	100	4	4	3.3	3.6
500	570	410	335	50	200	5	3	3.9	4.2
600	670	510	435	50	100	6	6	4.6	5.0

Note: Special ballscrew spindle end of 8 mm diameter is available, please contact hiwin if necessary.

SK60 (Light Duty)

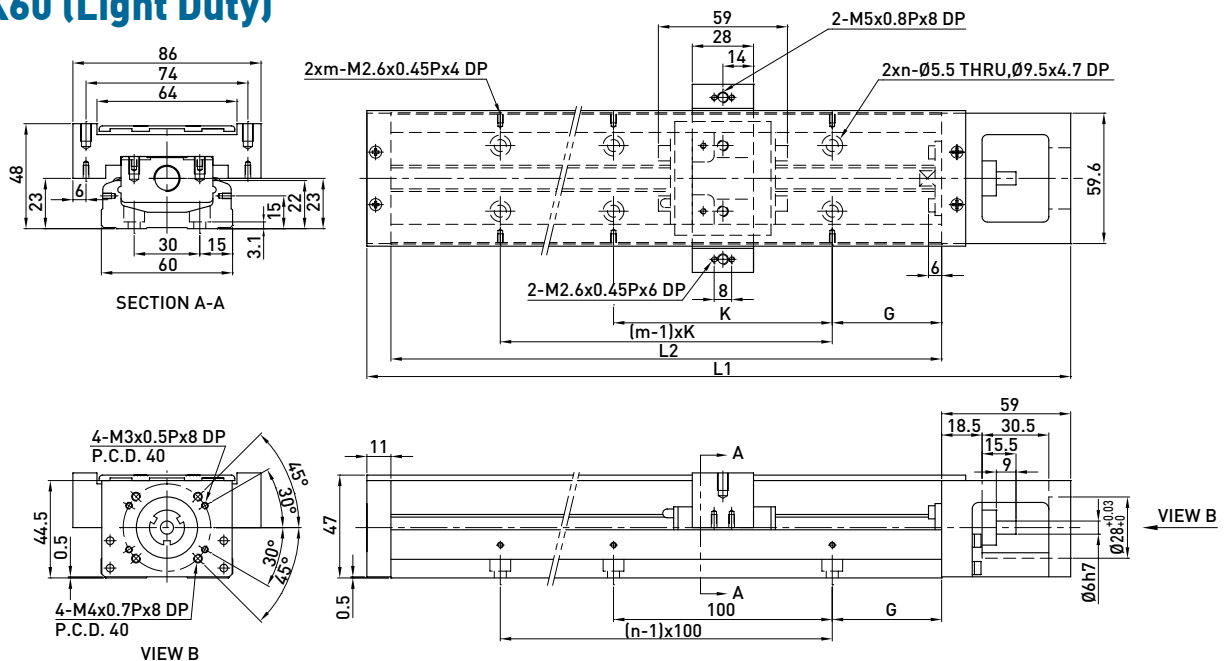

Rail Length L2 (mm)	Total Length L1 (mm)	Maximum Stroke (mm)		G (mm)	K (mm)	n	m	Mass (kg)	
		S1 Block	S2 Block					S1 Block	S2 Block
150	220	85	34	25	100	2	2	1.6	1.8
200	270	135	84	50	100	2	2	1.9	2.1
300	370	235	184	50	200	3	2	2.5	2.7
400	470	335	284	50	100	4	4	3.1	3.3
500	570	435	384	50	200	5	3	3.7	3.9
600	670	535	484	50	100	6	6	4.4	4.6

SK60D (Standard)

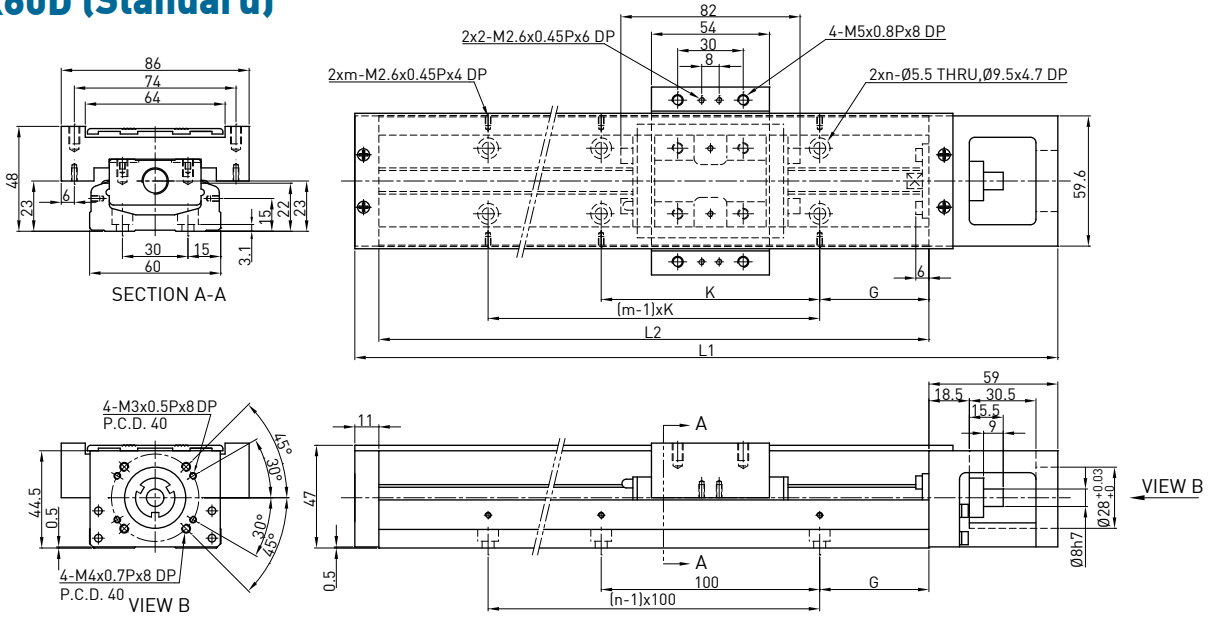

Rail Length L2 (mm)	Total Length L1 (mm)	Maximum Stroke (mm)		G (mm)	K (mm)	n	m	Mass (kg)	
		A1 Block	A2 Block					A1 Block	A2 Block
150	220	60	-	25	100	2	2	1.7	-
200	270	110	-	50	100	2	2	2.1	-
300	370	210	135	50	200	3	2	2.7	3.0
400	470	310	235	50	100	4	4	3.3	3.6
500	570	410	335	50	200	5	3	3.9	4.2
600	670	510	435	50	100	6	6	4.6	5.0

SK60D (Light Duty)

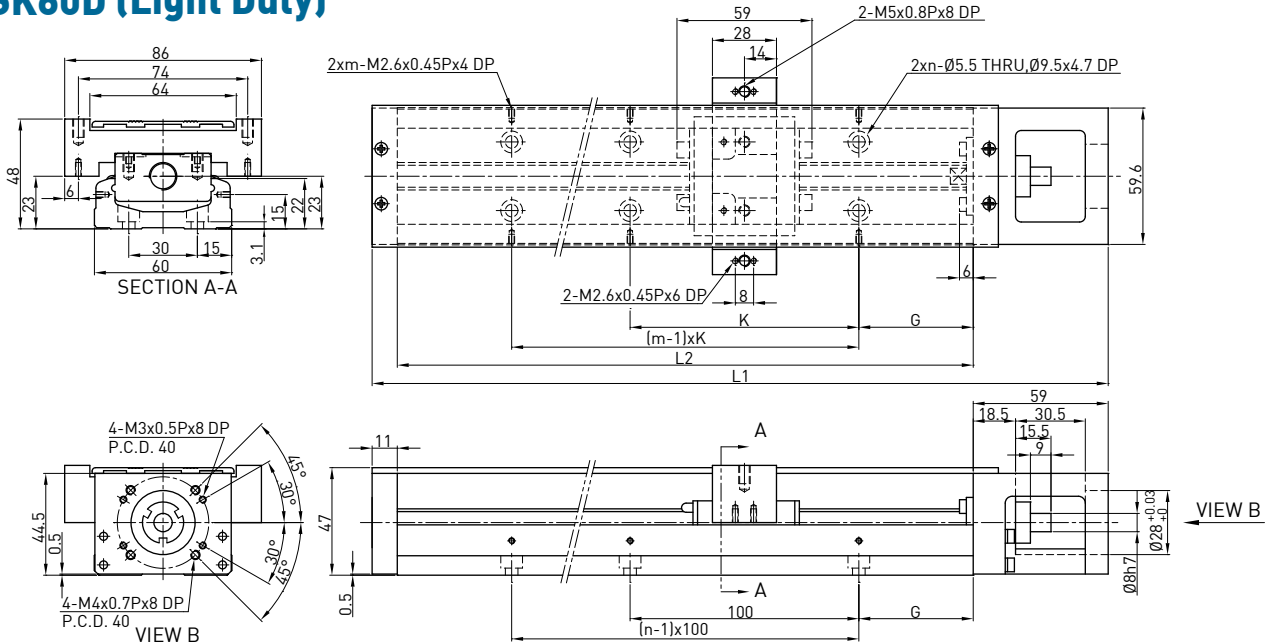

Rail Length L2 (mm)	Total Length L1 (mm)	Maximum Stroke (mm)		G (mm)	K (mm)	n	m	Mass (kg)	
		S1 Block	S2 Block					S1 Block	S2 Block
150	220	85	34	25	100	2	2	1.6	1.8
200	270	135	84	50	100	2	2	1.9	2.1
300	370	235	184	50	200	3	2	2.5	2.7
400	470	335	284	50	100	4	4	3.1	3.3
500	570	435	384	50	200	5	3	3.7	3.9
600	670	535	484	50	100	6	6	4.4	4.6

SK86 (Standard)

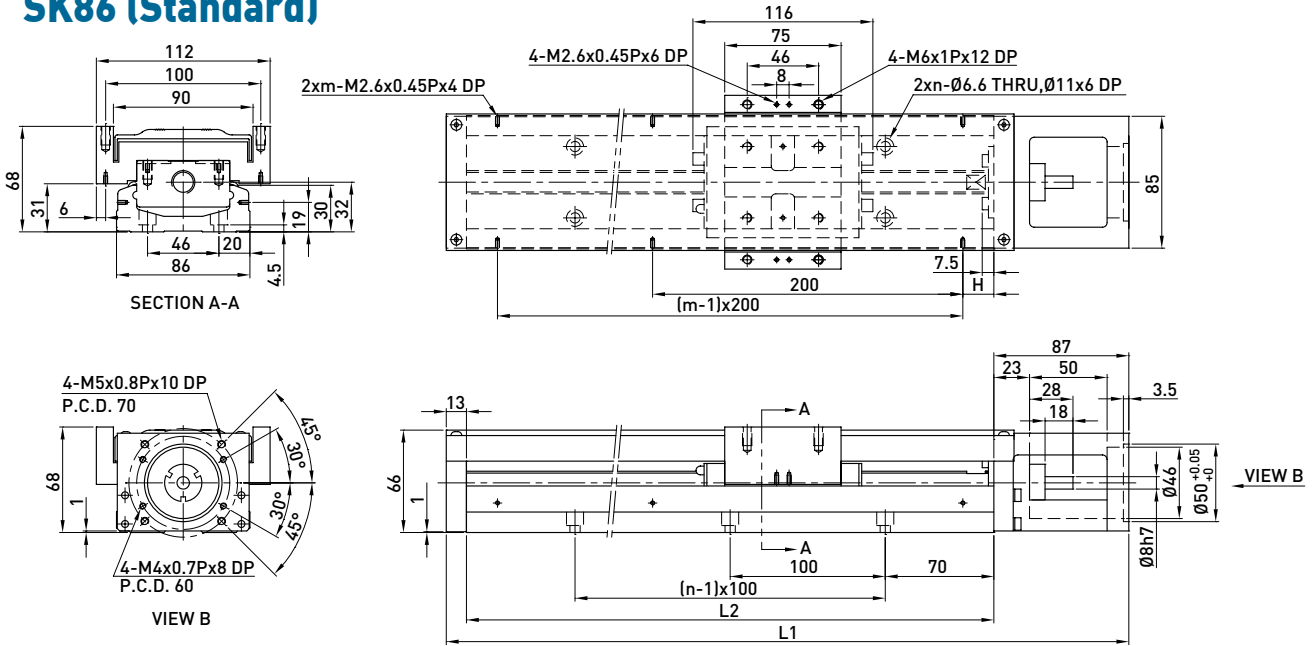

Rail Length L2 (mm)	Total Length L1 (mm)	Maximum Stroke (mm)		H (mm)	n	m	Mass (kg)	
		A1 Block	A2 Block				A1 Block	A2 Block
340	440	216.5	108.5	70	3	2	6.5	7.3
440	540	316.5	208.5	20	4	3	7.8	8.6
540	640	416.5	308.5	70	5	3	9.0	9.8
640	740	516.5	408.5	20	6	4	10.3	11.3
740	840	616.5	508.5	70	7	4	11.6	12.4
940	1040	816.5	708.5	70	9	5	13.0	13.8

Note: Special ballscrew spindle end of 10 mm diameter is available, please contact hiwin if necessary.

SK86 (Light Duty)

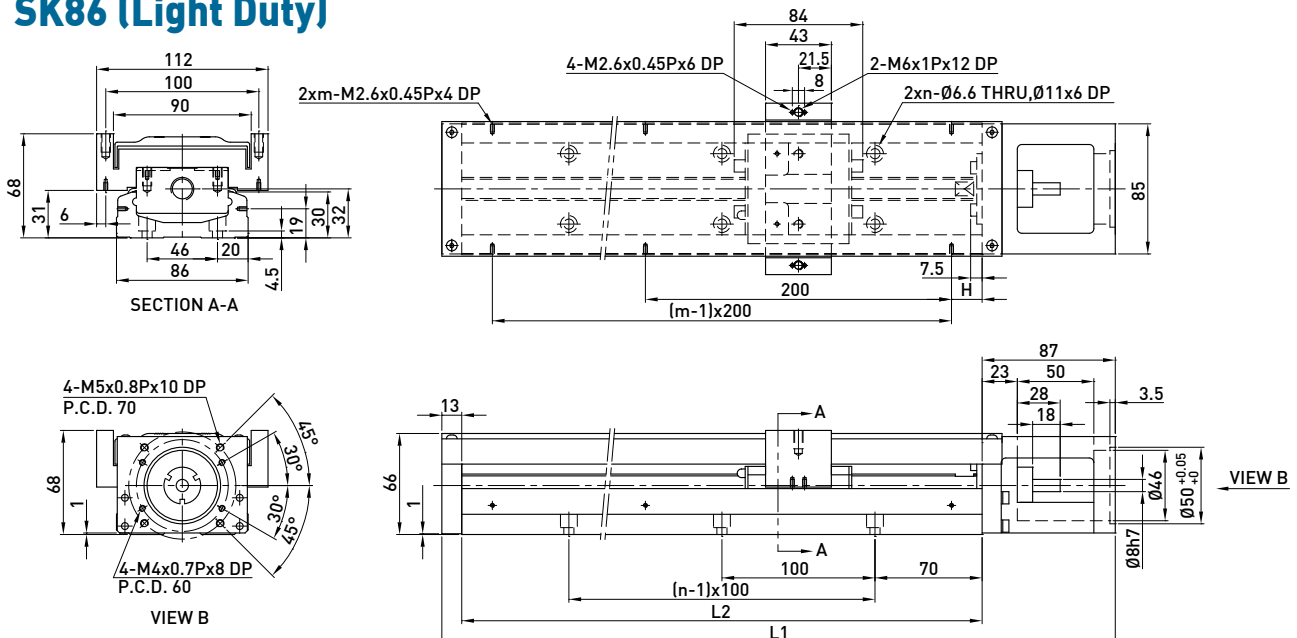

Rail Length L2 (mm)	Total Length L1 (mm)	Maximum Stroke (mm)		H (mm)	n	m	Mass (kg)	
		S1 Block	S2 Block				S1 Block	S2 Block
340	440	248.5	172.5	70	3	2	6.3	7.1
440	540	348.5	272.5	20	4	3	7.6	8.4
540	640	448.5	372.5	70	5	3	8.8	9.6
640	740	548.5	472.5	20	6	4	10.1	11.1
740	840	648.5	572.5	70	7	4	11.4	12.2
940	1040	848.5	772.5	70	9	5	12.8	13.6

SK86D (Standard)

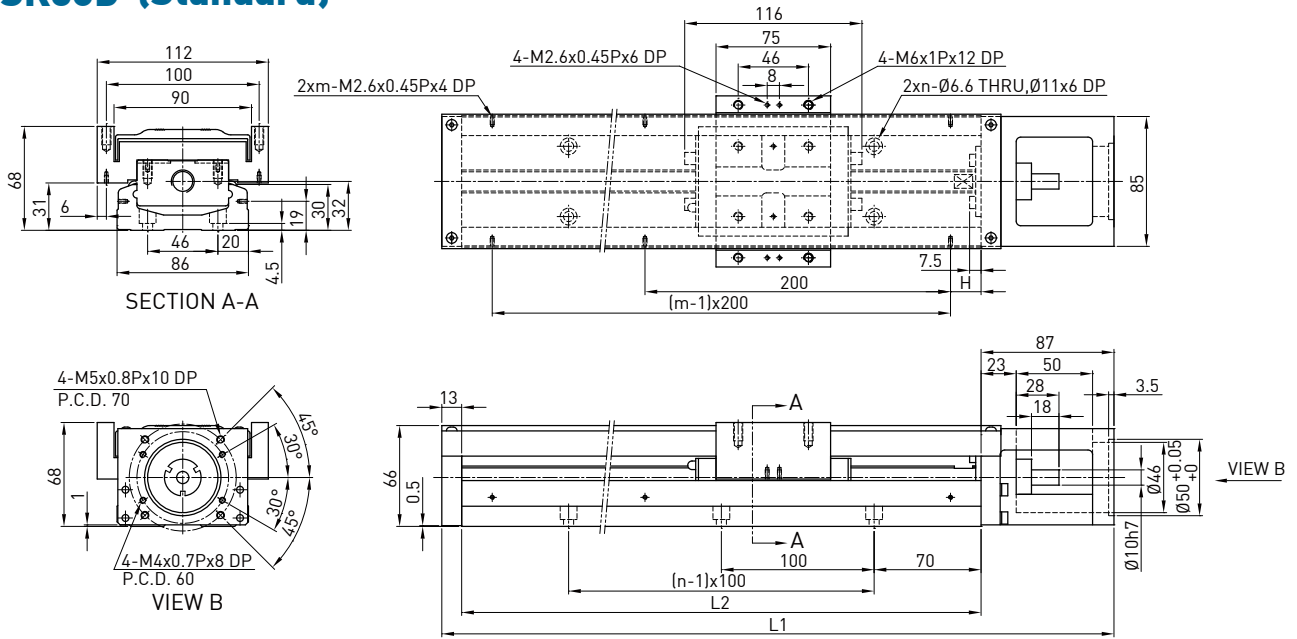

Rail Length L2 (mm)	Total Length L1 (mm)	Maximum Stroke (mm)		H (mm)	n	m	Mass (kg)	
		A1 Block	A2 Block				A1 Block	A2 Block
340	440	216.5	108.5	70	3	2	6.5	7.3
440	540	316.5	208.5	20	4	3	7.8	8.6
540	640	416.5	308.5	70	5	3	9.0	9.8
640	740	516.5	408.5	20	6	4	10.3	11.3
740	840	616.5	508.5	70	7	4	11.6	12.4
940	1040	816.5	708.5	70	9	5	13.0	13.8

SK86D (Light Duty)

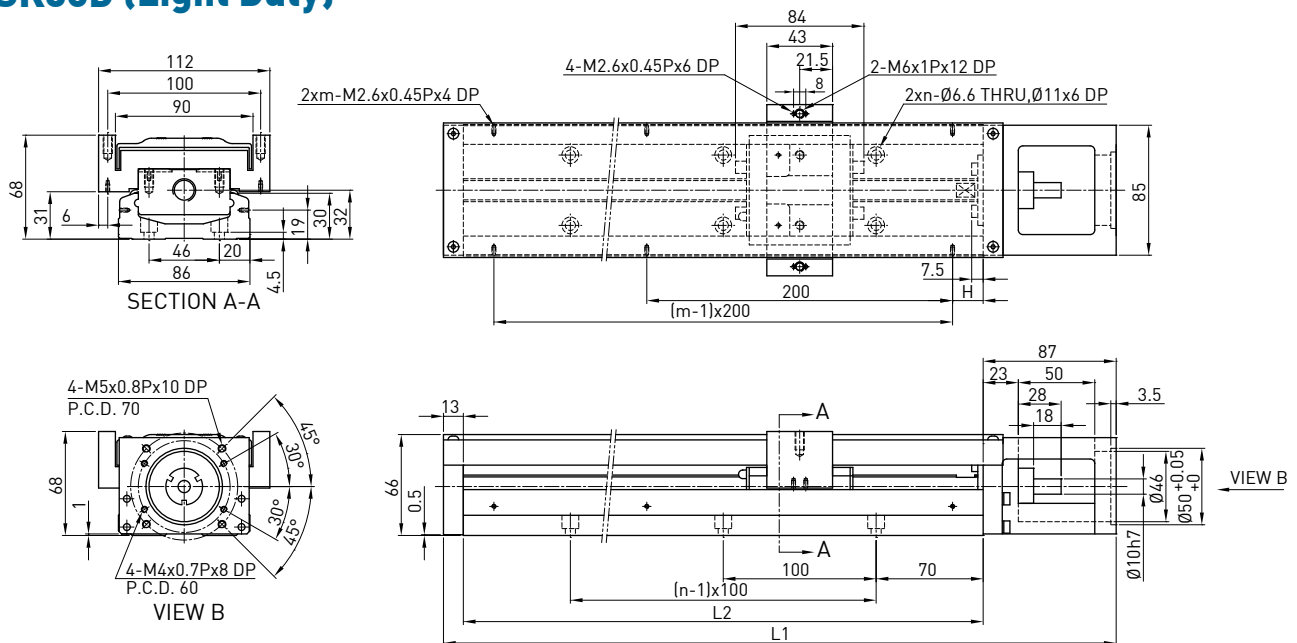

Rail Length L2 (mm)	Total Length L1 (mm)	Maximum Stroke (mm)		H (mm)	n	m	Mass (kg)	
		S1 Block	S2 Block				S1 Block	S2 Block
340	440	248.5	172.5	70	3	2	6.3	7.1
440	540	348.5	272.5	20	4	3	7.6	8.4
540	640	448.5	372.5	70	5	3	8.8	9.6
640	740	548.5	472.5	20	6	4	10.1	11.1
740	840	648.5	572.5	70	7	4	11.4	12.2
940	1040	848.5	772.5	70	9	5	12.8	13.6

3.9 Motor Housing and Motor Adaptor Flange

3.9.1 Motor Selection

HIWIN Mikrosystem Servo Motor

Motor Output	Motor	Weight (kg)	Flange Selection		+Brake Weight (kg)	Drive	Weight (kg)	Remarks
			SK60	SK86				
50W	FRLS052□□A4□	0.45	F2	F3	0.58	D2T	1.25	220V
100W	FRLS102□□A4□	0.6	F2	F3	0.76			220V
200W	FRLS202□□06□	1	-	F0	1.5			220V
400W	FRLS402□□06□	1.45	-	F0	1.86			220V
750W	FRMS752□□08□	2.66	-	-	3.32			220V

Mitsubishi Servo Motor

Motor Output	Motor	Weight (kg)	Flange Selection		+Brake Weight (kg)	Drive	Weight (kg)	Remarks
			SK60	SK86				
50W	HF-KP053	0.35	F1	F2	0.75	MR-J3S-10A	0.8	220V
100W	HF-KP13	0.56	F1	F2	0.89	MR-J3S-10A	0.8	220V
200W	HF-KP23	0.94	-	F0	1.6	MR-J3S-20A	0.8	220V
400W	HF-KP43	1.5	-	F0	2.1	MR-J3S-40A	1	220V

Panasonic Servo Motor

Motor Output	Motor	Weight (kg)	Flange Selection		+Brake Weight (kg)	Drive	Weight (kg)	Remarks
			SK60	SK86				
50W	MSMD5AZP1	0.32	F2	F3	0.53	MADDT1105	0.8	110V
50W	MSMD5AZP1	0.32	F2	F3	0.53	MADDT1205	0.8	220V
100W	MSMD011P1	0.47	F2	F3	0.68	MADDT1107	0.8	110V
100W	MSMD012P1	0.47	F2	F3	0.68	MADDT1205	0.8	220V
200W	MSMD021P1	0.82	-	F1	1.3	MADDT2110	1.1	110V
200W	MSMD022P1	0.82	-	F1	1.3	MADDT1207	0.8	220V
400W	MSMD041P1	1.2	-	F1	1.7	MADDT3120	1.5	110V
400W	MSMD042P1	1.2	-	F1	1.7	MADDT2210	1.1	220V
750W	MSMD082S1	2.3	-	F4	3.1	MADDT3520	1.5	220V

Yaskawa Servo Motor

Motor Output	Motor	Weight (kg)	Flange Selection		+Brake Weight (kg)	Drive	Weight (kg)	Remarks
			SK60	SK86				
50W	SGMAV-A5ADA61	0.3	F1	F2	-	SGDV-R70A01A	0.9	with key
50W	SGMAV-A5ADA2C	0.3	F1	F2	-	SGDV-R70A01A	0.9	no key
50W	SGMAV-A5ADA21	0.3	F1	F2	0.75	SGDV-R70A01A	0.9	Mid inertia
100W	SGMAV-01ADA64	0.4	F1	F2	0.89	SGDV-R90A01A	0.9	-
200W	SGMAV-02ADA65	0.9	-	F0	1.6	SGDV-1R6A01A	0.9	-
400W	SGMAV-04ADA66	1.2	-	F0	2.1	SGDV-2R8A01A	1	-

Oriental Step Motor

Series	Model	Flange Selection		Built in Motor	Weight (kg)	Built in Drive	Weight (kg)
		SK60	SK86				
CSK 2 phase	CSK243-AP	F5	-	PK243-01A	0.21	CSD2109-P	0.12
	CSK244-AP	F5	-	PK244-01A	0.27	CSD2112-P	0.12
	CSK245-AP	F5	-	PK245-01A	0.35	CSD2112-P	0.12
	CSK264-AP	F4	F6	PK264-02A	0.45	CSD2120-P	0.12
	CSK266-AP	F4	F6	PK266-02A	0.7	CSD2120-P	0.12
	CSK268-AP	F4	F6	PK268-02A	1	CSD2120-P	0.12
CFKII 5 phase micro stepping	CFK543AP2	F5	-	PK543NAW	0.21	DFC5107P	0.2
	CFK544AP2	F5	-	PK544NAW	0.27	DFC5107P	0.2
	CFK545AP2	F5	-	PK545NAW	0.35	DFC5107P	0.2
	CFK564AP2	-	F5	PK564NAW	0.6	DFC5114P	0.2
	CFK566AP2	-	F5	PK566NAW	0.8	DFC5114P	0.2
	CFK569AP2	-	F5	PK569NAW	1.3	DFC5114P	0.2
	CFK566HAP2	-	F5	PK566HNAW	0.8	DFC5128P	0.22
	CKF569HAP2	-	F5	PK569HNAW	1.3	DFC5128P	0.22
UMK 2 phase	UMK243A	F5	-	PK243-01	0.21	UDK2109	0.47
	UMK244A	F5	-	PK244-01	0.27	UDK2112	0.47
	UMK245A	F5	-	PK245-01	0.35	UDK2112	0.47
	UMK264A	F4	F6	PK264-02	0.45	UDK2120	0.47
	UMK266A	F4	F6	PK266-02	0.7	UDK2120	0.47
	UMK268A	F4	F6	PK268-02	1	UDK2120	0.47
RK 5 phase	RK543AA	F5	-	PK543W	0.25	RKD507-A	0.4
	RK544AA	F5	-	PK544W	0.3	RKD507-A	0.4
	RK545AA	F5	-	PK545W	0.4	RKD507-A	0.4
	RK566AA	-	F5	PK566W	0.8	RKD514L-A	0.85
	RK569AA	-	F5	PK569W	1.3	RKD514L-A	0.85

3.9.2 HIWIN AC Servo Motor & Drive Selection Model Comparison Table

SK60

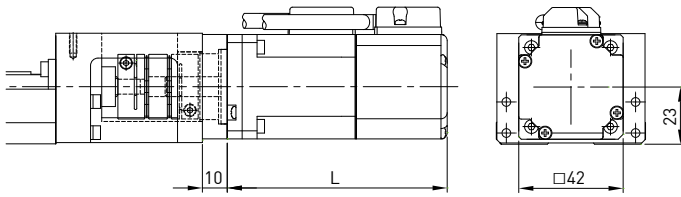

Model selection	Rated Output	Brakes	Flange	L(mm)	Weight (kg)*
M05□	50W	NO	F2	88.5	0.51
K05□		YES		117	0.64
M10□	100W	NO		110.5	0.66
K10□		YES		139	0.82

SK86

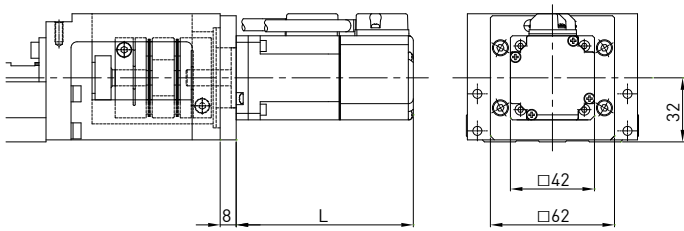

Model selection	Rated Output	Brakes	Flange	L(mm)	Weight (kg)*
M05□	50W	NO	F3	88.5	0.65
K05□		YES		117	0.78
M10□	100W	NO		110.5	0.80
K10□		YES		139	0.96

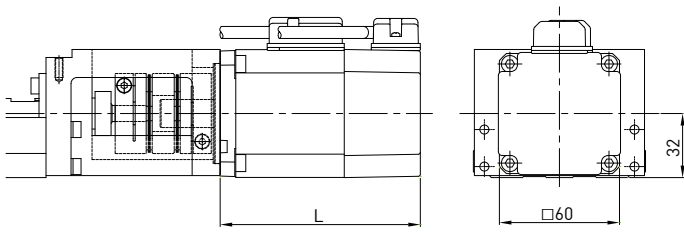

Model selection	Rated Output	Brakes	Flange	L(mm)	Weight (kg)*
M20□	200W	NO	F0	100	1.13
K20□		YES		133	1.63
M40□	400W	NO		121.5	1.58
K40□		YES		154.5	1.99

*1. The weight is the total weight of the motor, flange and coupling. It does not include the weight of the single-axis robot.
2. Motor and drive specification ref. catalog P.167

3.9.3 Motor Housing and Motor Adaptor Flange

SK60

Motor Housing F0

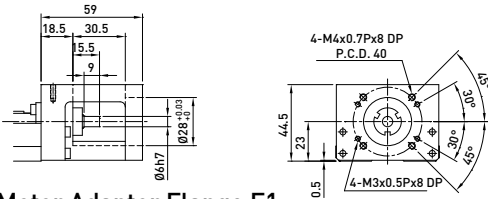

Motor Adaptor Flange F1

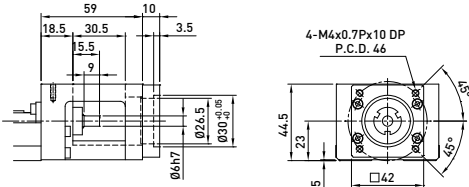

Motor Adaptor Flange F2

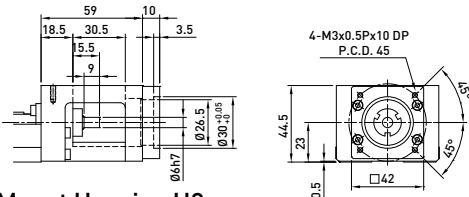

Mount Housing H0

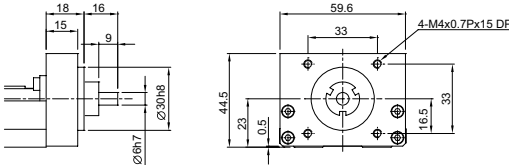

Motor Adaptor Flange F3

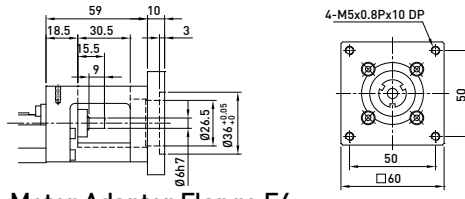

Motor Adaptor Flange F4

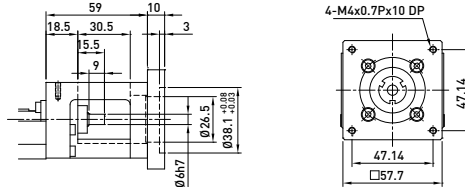

Motor Adaptor Flange F5

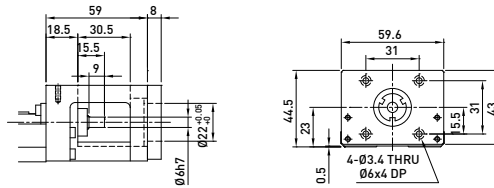

Mount Housing H1

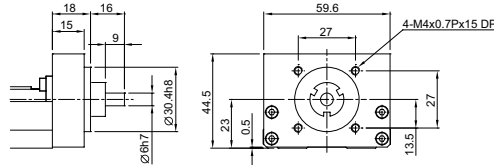

SK86

Motor Housing F0

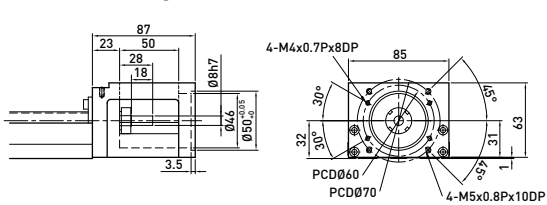

Motor Adaptor Flange F1

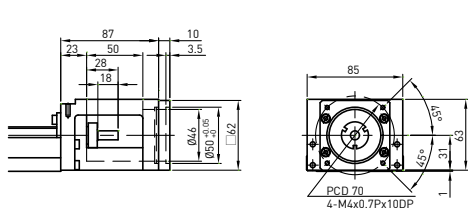

Motor Adaptor Flange F2

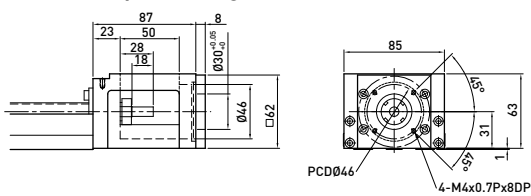

Motor Adaptor Flange F3

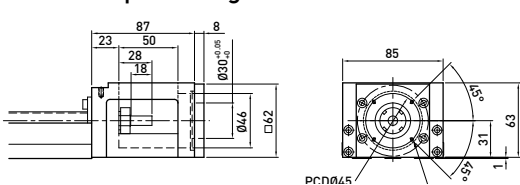

Motor Adaptor Flange F4

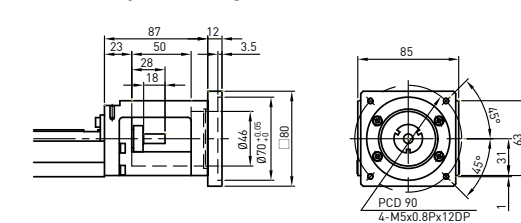

Motor Adaptor Flange F5

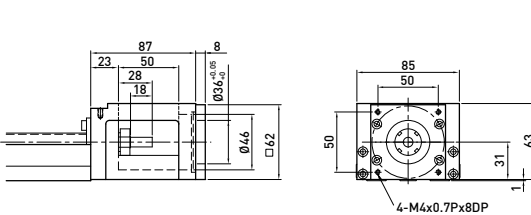

Motor Adaptor Flange F6

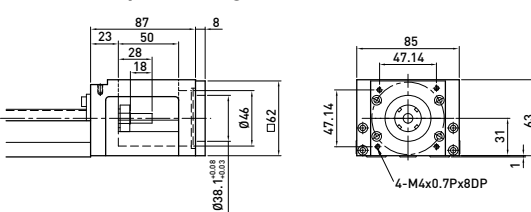

Mount Housing H0

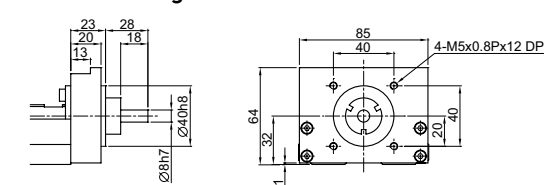

3.10 Switch

Switch rail

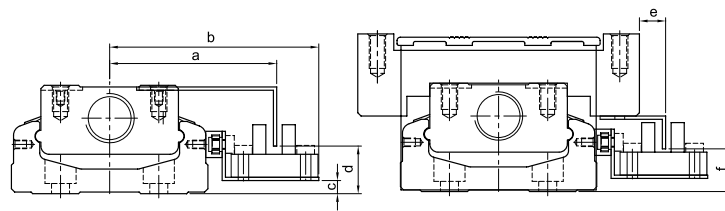
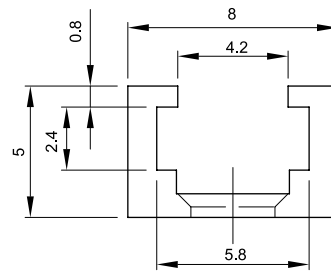

Nominal Width	a	b	c	d	e	f
SK60	51	63.8	4	14.5	8	13
SK86	63.5	76.7	8	18	8	18

Switch S1 : Omron EE-SX671

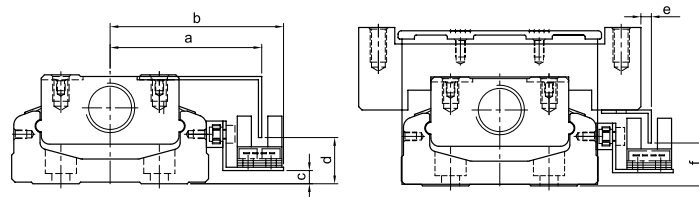

Nominal Width	a	b	c	d	e	f
SK60	46.2	52.8	4	14	3.2	13
SK86	59	65.7	8	18	3	18

Switch S2 : Omron EE-SX674

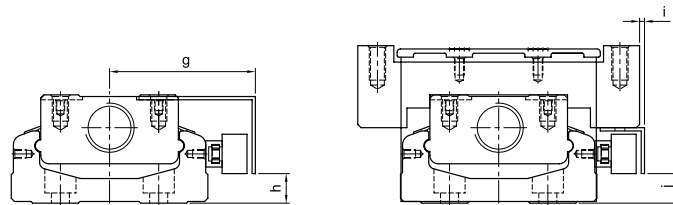

Nominal Width	g	h	i	j
SK60	44.5	9	2	9
SK86	57	13	1	13

Switch S3, S4 : PANASONIC GX-F12A, PANASONIC GX-F12A-P